

KSEF-B Bifurcated Axial Fan



Description :

Bifurcated axial fans can be used when motor should be out of the airstream but a belt driven model cannot be used. When continuous use required in high temperature motor can be cooled by attaching a KAS fan.

MOTOR PROTECTION CLASS	IP 55
MOTOR INSULATION CLASS	F CLASS
MOTOR EFFICIENCY CLASS	IE2-IE3
MOTOR BRAND	GAMAK-VOLT-WAT
MOTOR ENCLOSURE TYPE	TEFC
BODY MATERIAL	GALVANIZED SHEET METAL
BODY COATING	OPTIONAL
IMPELLER TYPE	AXIAL
IMPELLER MATERIAL	ALUMINIUM SHEET METAL
DUTY CYCLE	IEC Duty Cycle-S1
WORKING AMBIENT TEMP	-20 - +50 °C
DIRECTIVE	IEC-60335-2-80, ISO 1940-1



TECHNICAL SPECIFICATIONS

MODEL	VOLTAGE (V)	FREQUENCY (Hz)	POWER (kW)	REV. (RPM)	FLOW RATE (m3/h)	SOUND PRESSURE dB(A) 3m
KSEF-B 710-5-30	380	50	1,50	1.472	17.000	83
KSEF-B 800-5-30	380	50	2,20	1.459	22.250	85
KSEF-B 800-5-35	380	50	3,00	1.463	26.940	89
KSEF-B 900-5-35	380	50	4,00	1.471	34.150	90
KSEF-B 900-5-40	380	50	5,50	1.472	40.000	93
KSEF-B 1000-5-40	380	50	7,50	1.478	49.570	94
KSEF-B 900-8-40	380	50	11,00	1.454	43.200	94
KSEF-B 1000-8-40	380	50	15,00	1.456	58.850	97
KSEF-B 1000-8-45	380	50	18,50	1.458	66.070	99
KSEF-B 1120-8-40	380	50	22,00	1.471	84.620	100
KSEF-B 1120-8-45	380	50	30,00	1.474	92.270	102

Values are for 0 Pa

OPTIONS

Description : All options are available for all KSEF-B models. Panel powers alternatives : 5,5 kW - 7,5 kW - 11,0 kW - 15,0 kW - 18,5 kW - 22,0 kW - 30,0 kW



GRILLE GUARD



SUPPORT FEET



DUCT FLANGE



CONNECTOR



RUBBER PAD



SPRING



PANEL

OTHER OPTIONS

- Electro-static Powder Coating With Any RAL Color
- Custom Production For Any Flowrate and Pressure
- 5, 8, 12 and 16 Blades Options
- Aluminium or Plastic Blades
- System Automation
- Two-Speed Motor Option

TECHNICAL DRAWING

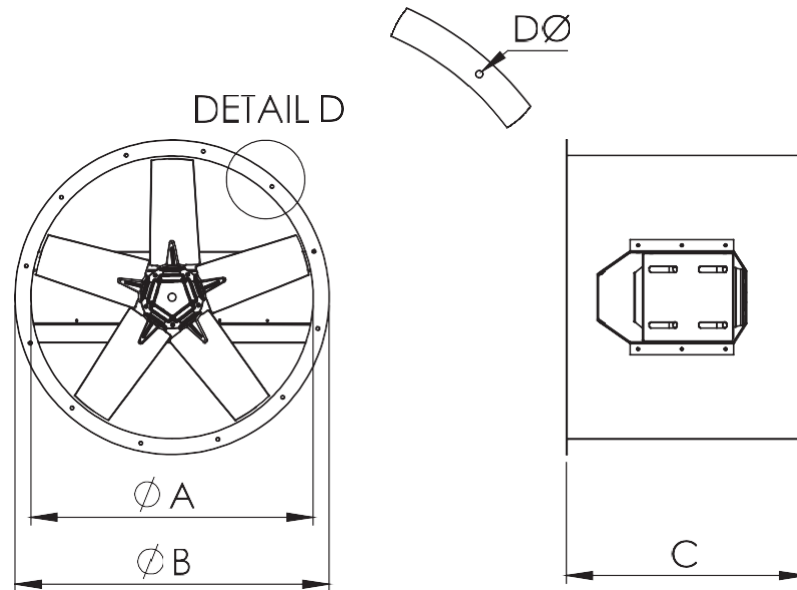

MODEL	A (mm)	B (mm)	C (mm)	D (mm)	N (Number of Holes)
KSEF-B 710	710	790	600	11	12
KSEF-B 800	800	880	650	11	16
KSEF-B 900	900	980	700	11	16
KSEF-B 1000	1000	1080	740	11	16
KSEF-B 1120	1120	1200	800	11	16

KSEF-B Performance Curves

KSEF-B 710-5-30

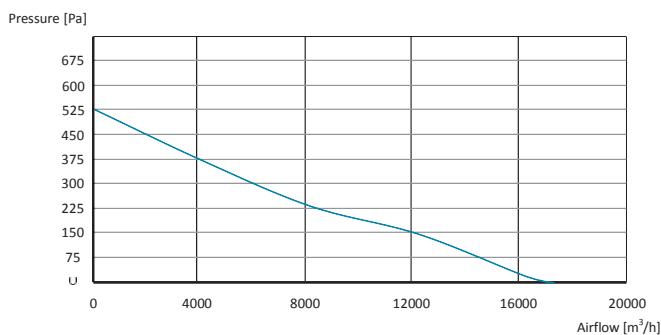

KSEF-B 800-5-30

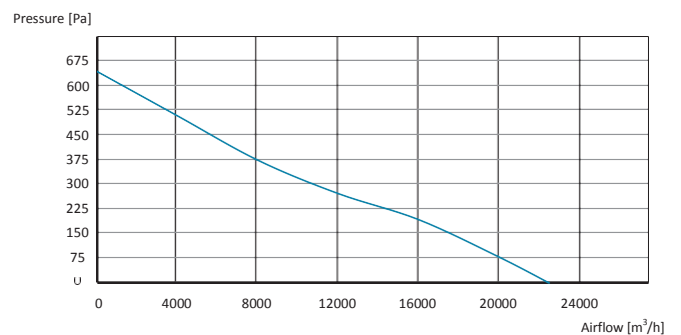

KSEF-B Performance Curves

KSEF-B 800-5-35

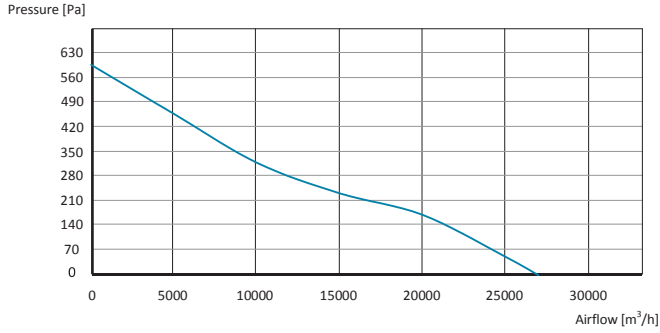

KSEF-B 900-5-35

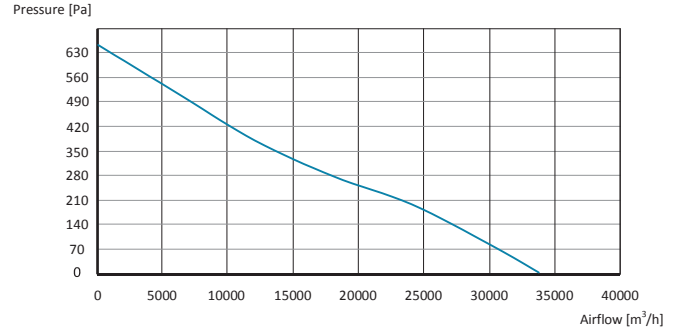

KSEF-B 900-5-40

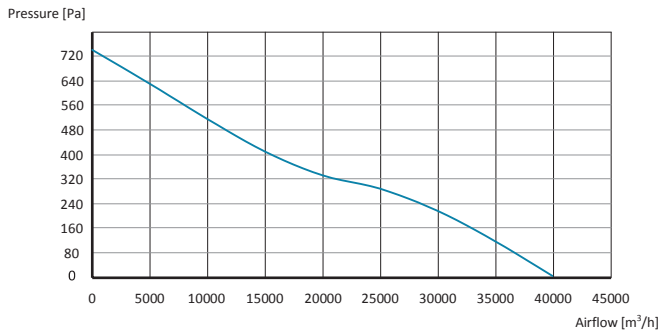

KSEF-B 1000-5-40

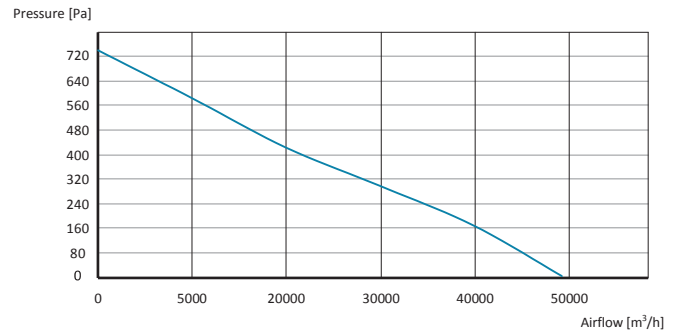

KSEF-B 900-8-40

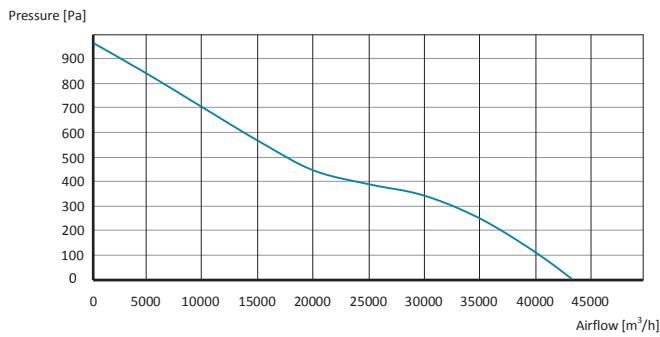

KSEF-B 1000-8-40

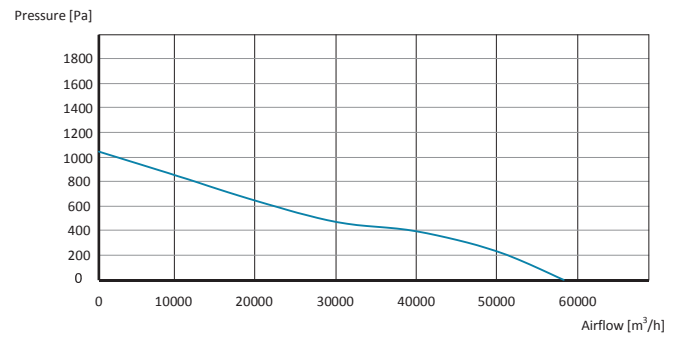

KSEF-B 1000-8-45

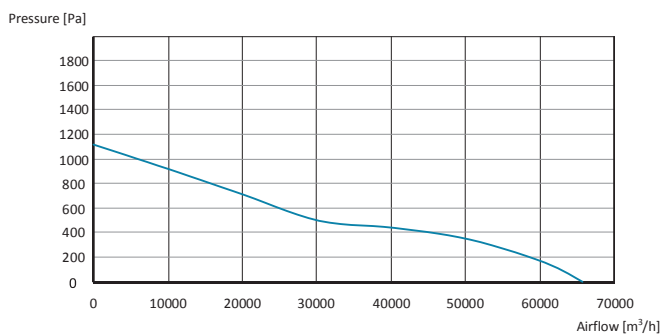

KSEF-B 1120-8-40

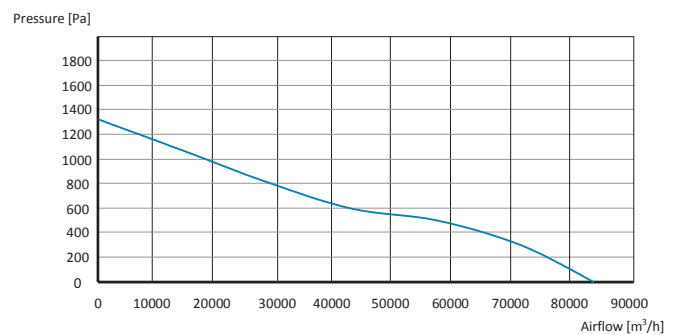

KSEF-B Performance Curves

KSEF-B 1120-8-45

